

RAIN BIRD SDI
SubSurface Drip Irrigation



ITTEC
irrigation & turf technologies

- **SDI** = Subsurface Drip Irrigation (podpovrchová kapková závlaha)
- Je určena k zavlažování trávnickových ploch a ploch s výsadbami kapkovacím potrubím, které je uloženo pod povrchem terénu v kořenové zóně zavlažovaných rostlin v hloubce cca 10-15cm.



CO JE SDI ?

- Úzké pásy
- Tvarované plochy
- Okolí obrubníků
- Tramvajové pásy
- Zelené střechy



SDI - APLIKACE



SDI - APLIKACE

- RAIN BIRD a ITTEC představují :

Kapkovací potrubí pro podpovrchovou instalaci XF-SDI



2010 Irrigation Show
Award Winner
Best New Product
for Turf/Landscape

RAIN BIRD – XF-SDI

- Copper Shield™ Technologie
- Kapkovače odolné proti nečistotám
- Extrémně flexibilní XF-SDI

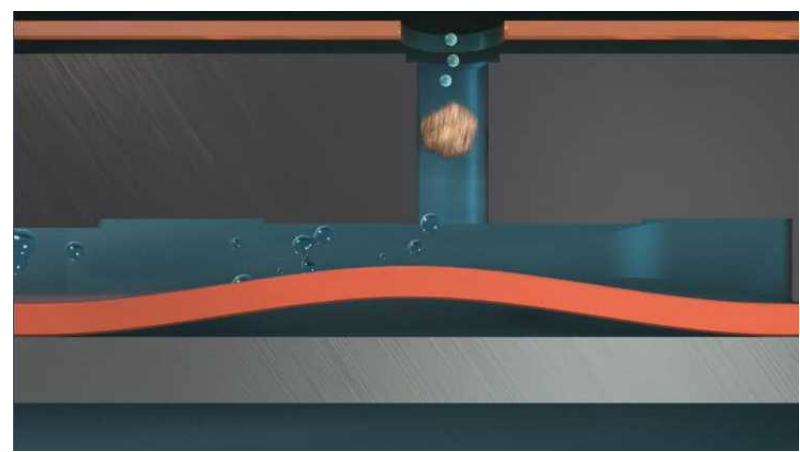
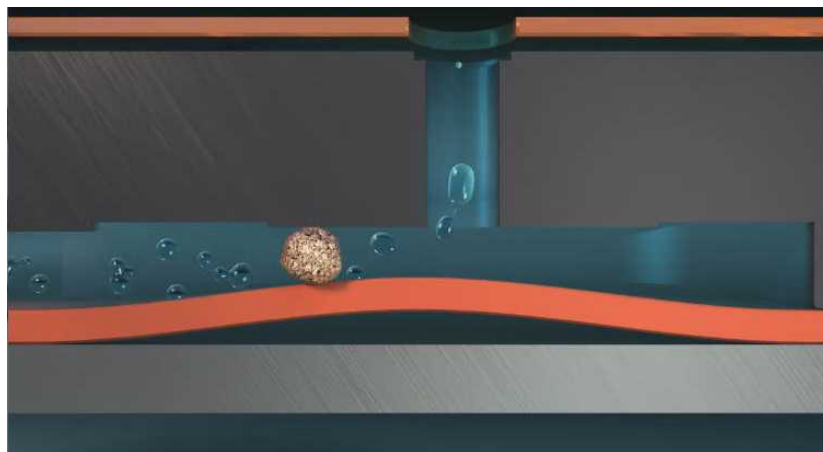

RAIN BIRD XF-SDI

Rain Bird Patent - Copper Shield™

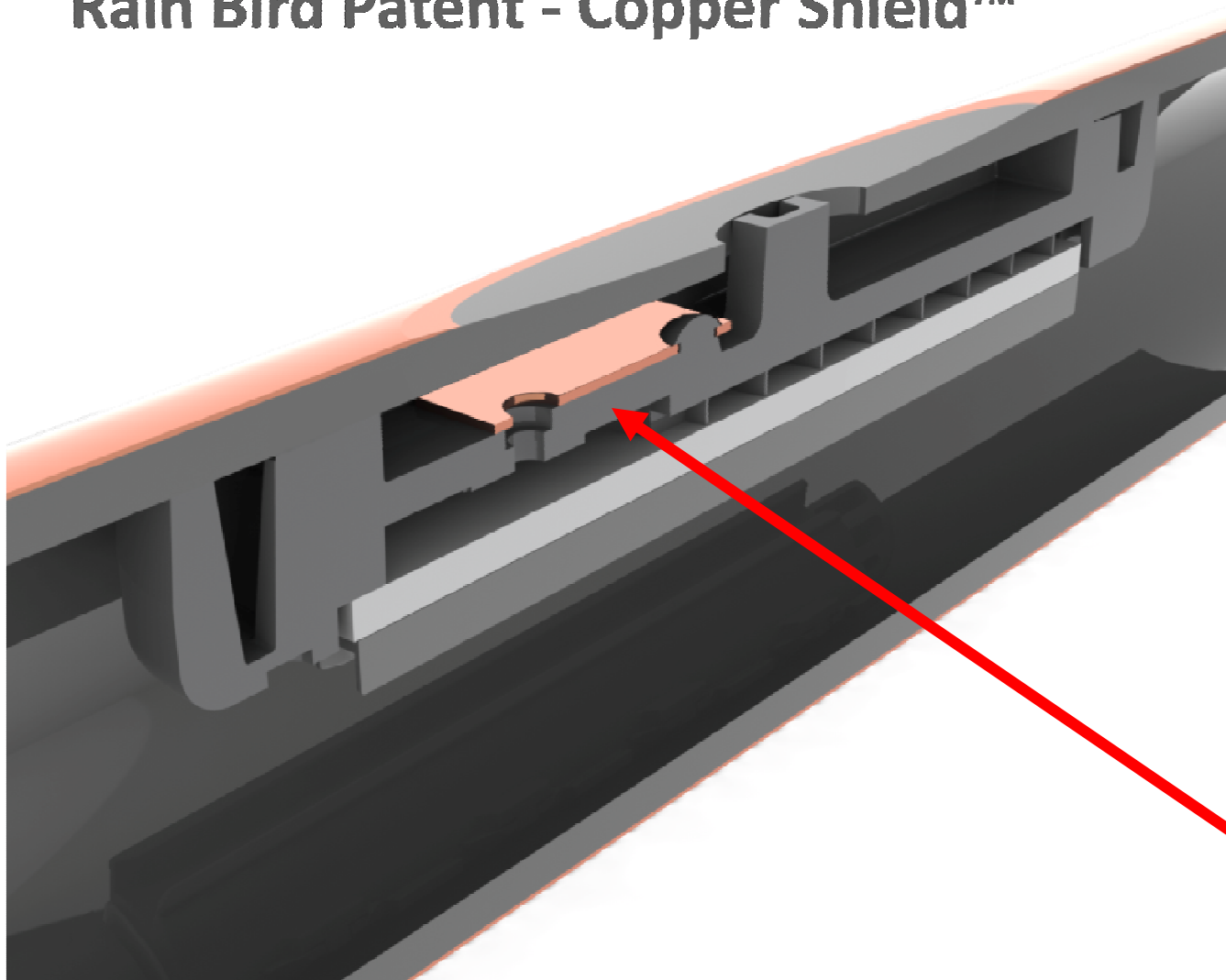

- Chrání kapkovače před vnikání kořenů a jejich prorůstání kapkovačem

- Technologie Copper Shield™

TECHNOLOGIE

- Kořeny vytvářejí organické kyseliny, které způsobují vylučování iontů mědi při vzájemném kontaktu.
- Ionty mědi způsobují ukončení růstu kořene, který vniká do kapkovače.
- Měď v konci kořene nepostupuje dále do rostliny, která pak zůstává nepoškozená a zdravá.

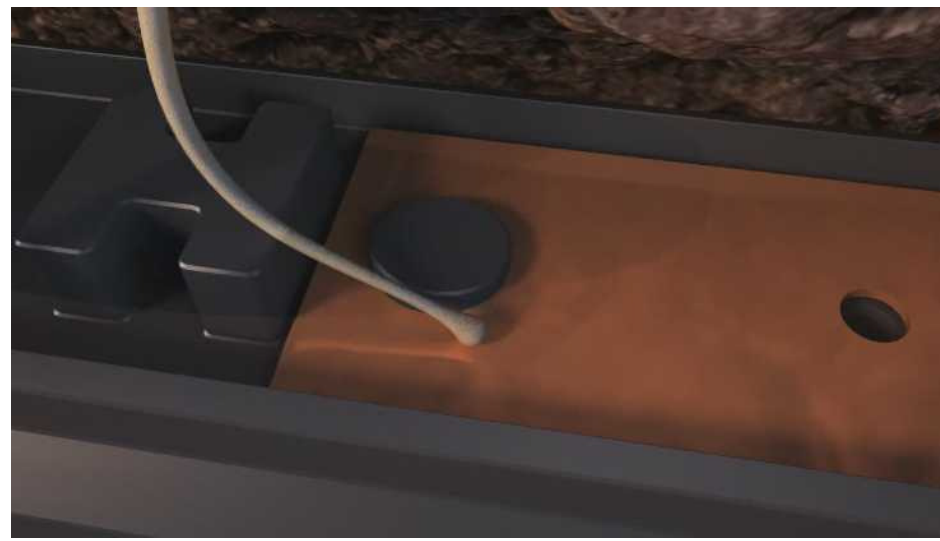

JAK COPPER SHIELD™ PRACUJE ?

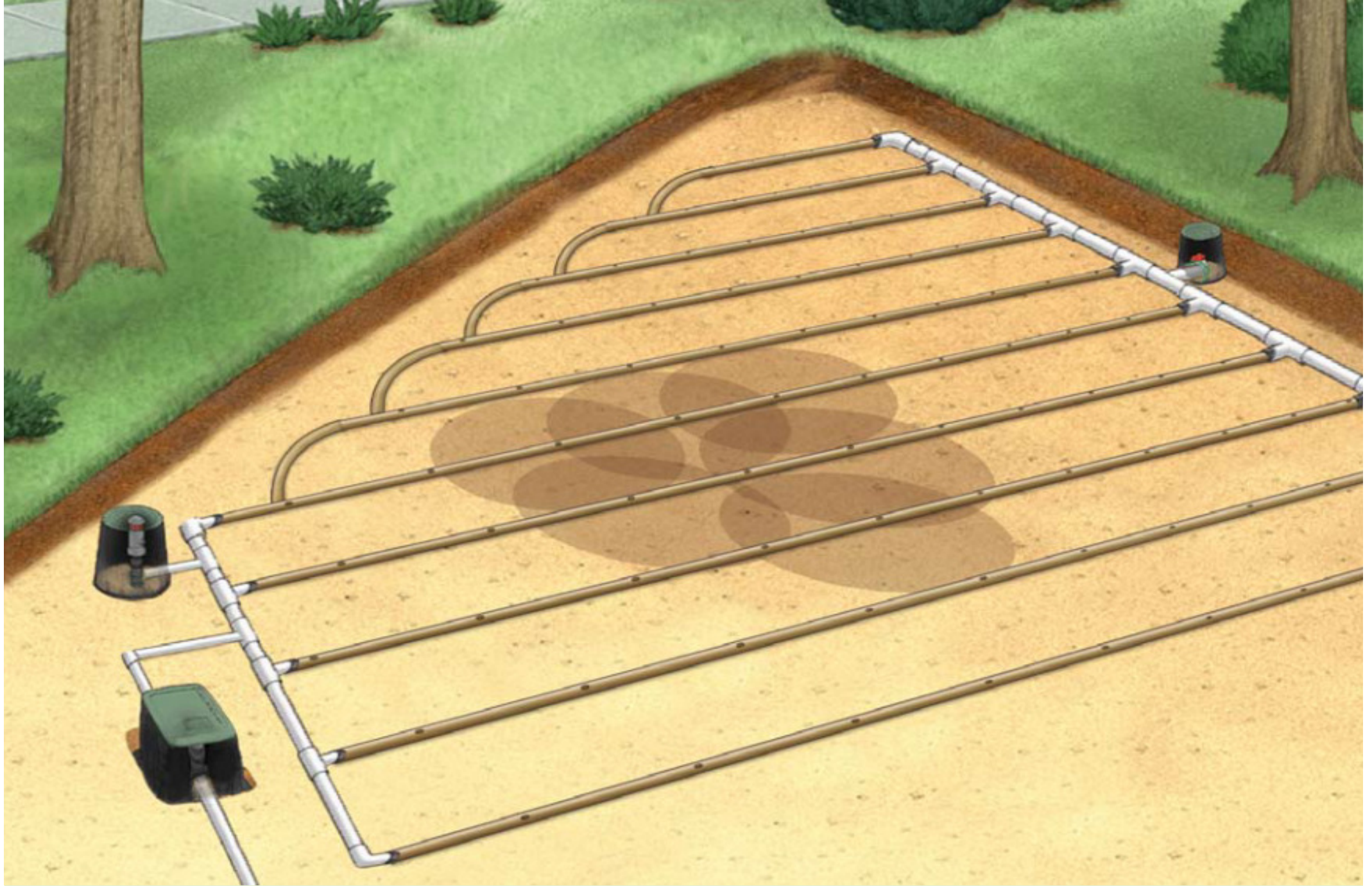

SDI...HLAVNÍ SOUČÁSTI

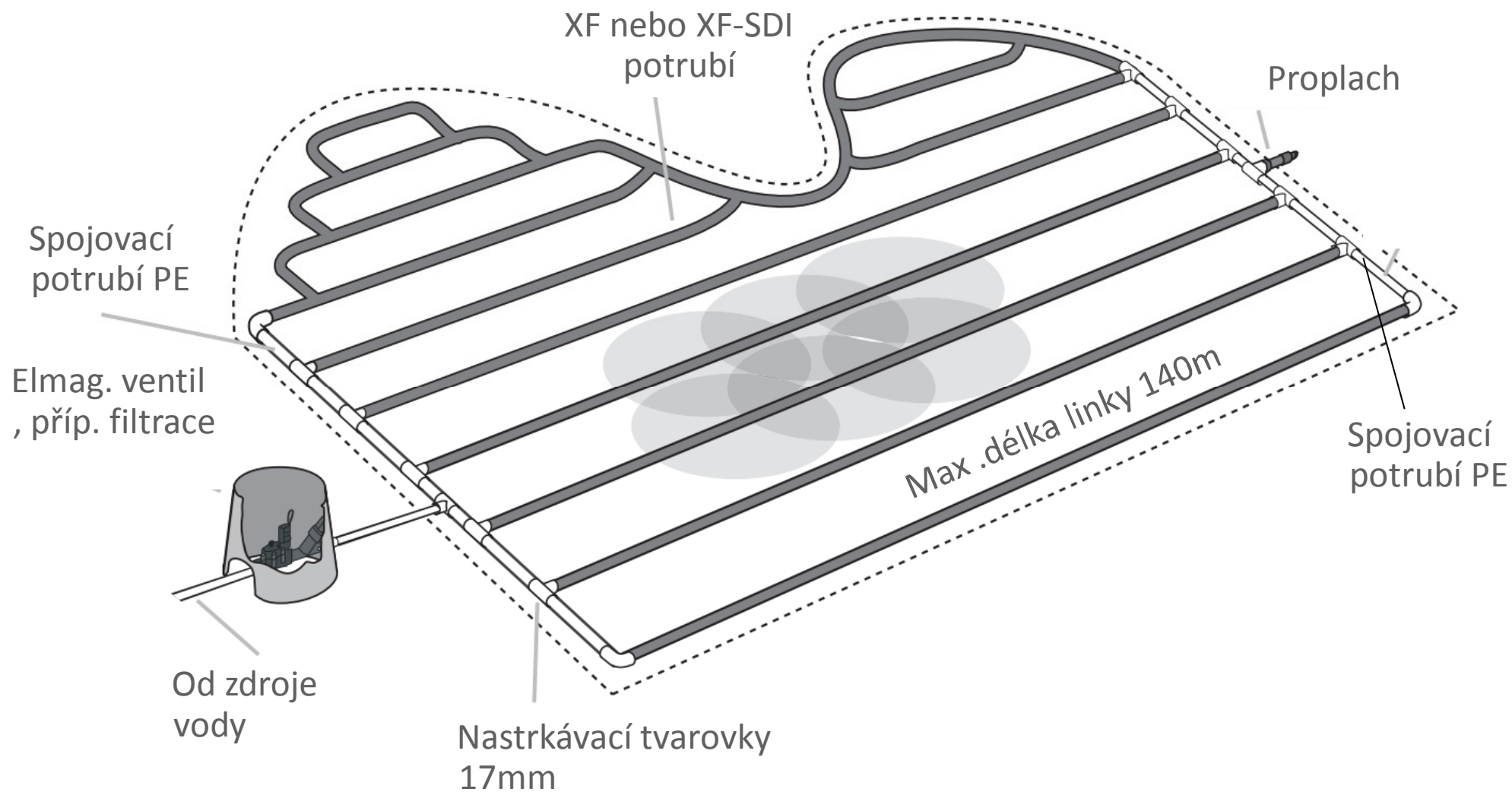

TECHNICKÉ ŘEŠENÍ

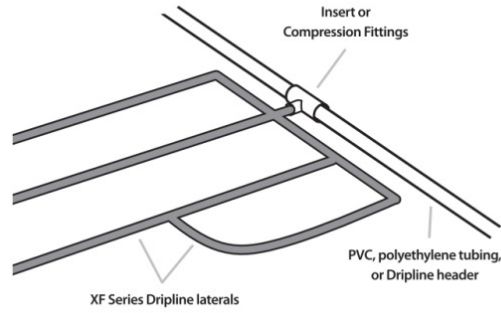

en
of
s
re

HLAVNÍ SOUČÁSTI SYSTÉMU

TECHNICKÉ ŘEŠENÍ

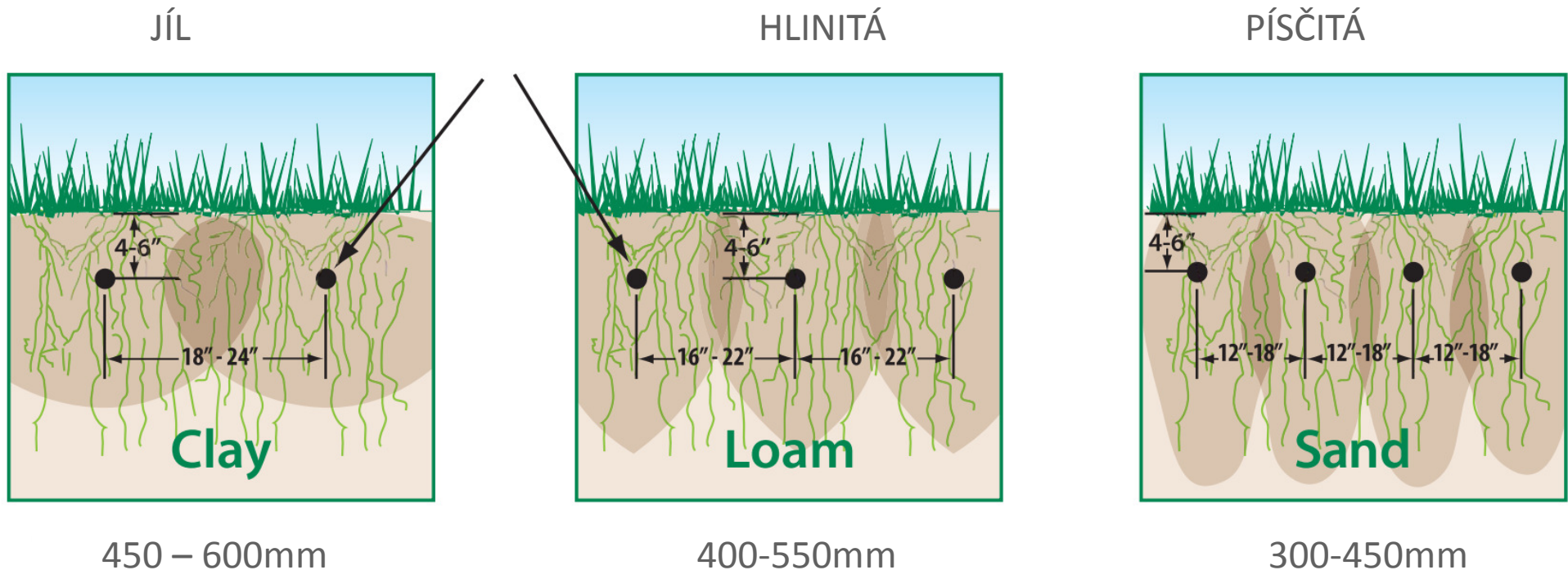

Hloubka uložení 100mm – 150mm

Ilustrace znázorňují pohyb vody při podpovrchové aplikaci.
Lze je aplikovat i pro kapkovací potrubí instalované na povrchu.

SPON A HLOUBKA ULOŽENÍ



STÁVAJÍCÍ TRÁVNÍKY



SPRÁVNÉ ŘEŠENÍ



NESPRÁVNÉ ŘEŠENÍ !!

TECHNICKÉ ŘEŠENÍ



NOVĚ ZAKLÁDANÉ TRÁVNÍKY



ZEMNÍ PRÁCE A XF-SDI

- Vysoká účinnost – až o 90% vyšší než systémy s postřikovači
- Odolnost proti vandalismu, zvířatům apod.
- Perfektní pro použití s recyklovanou vodou.
- Veškeré součásti systému jsou takřka neviditelné.
- Lze zavlažovat kdykoliv bez omezování provozu.
- Snadná a bezpečná aplikace kapalných hnojiv
- Vysoká životnost systému. Bez vlivu UV. Bez teplotních šoků pro rostliny.

VÝHODY SDI



ITTEC
irrigation & turf technologies

MODERNÍ ZÁVLAHOVÉ TECHNOLOGIE

